

## CALL FORWARDING DEVICE FOR 4+N

### *Ref. 9854/58*

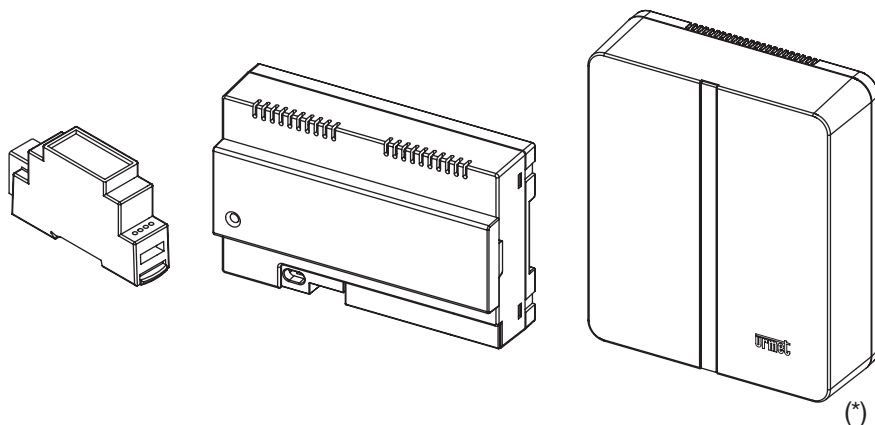

(\*) Wall surface mounting kit Ref. 1083/88

**COMPLETE USER AND INSTALLER MANUAL**

## INDEX

---

### USER MANUAL

1. NORMAL OPERATION .....	2
1.1. CALL RECEIVING .....	2
1.2. INTERCOM FUNCTION BETWEEN SMARTPHONES .....	4
2. THE Urmet CallMe APP .....	5
3. CREATE A NEW ACCOUNT OR USE A SAVED ACCOUNT .....	6
3.1. CREATE NEW ACCOUNT .....	6
3.2. USE A SAVED ACCOUNT (SIGN IN) .....	7
3.3. ACCOUNT MANAGEMENT .....	8

### INSTALLER MANUAL

4. DEVICE CONFIGURATION FROM THE Urmet CallMe APP .....	9
5. Urmet CallMe CONFIGURATION MENU .....	12
6. DEVICE INSTALLATION .....	12
6.1. IN A CONTROL PANEL .....	13
6.2. WALL MOUNTING WITH THE KIT REF. 1083/88 .....	14
6.3. DESCRIPTION OF COMPONENTS .....	15
7. TECHNICAL SPECIFICATIONS .....	16
7.1. KEY TO SYMBOLS .....	17
8. SIMPLIFIED EU DECLARATION OF CONFORMITY .....	17
9. CONNECTION DIAGRAMS .....	18
9.1. VIDEO DOOR PHONE SYSTEM WITH ELECTRONIC CALL .....	18
9.2. DOOR PHONE SYSTEM WITH ELECTRONIC CALL .....	19
9.3. KEY TO DIAGRAMS .....	20
9.4. NOTES ON DIAGRAMS .....	20

## USER MANUAL

### 1. NORMAL OPERATION

---

#### 1.1. CALL RECEIVING

To be able to receive video door phone calls on your smartphone, you must:

- Have the Urmet CallMe App (with notifications enabled) installed on your Smartphone.
- Have the app open (it may also be open in background.)

NOTE: If the app is closed unintentionally, you will be unable to receive calls!  
Smartphone battery use optimisation or energy

saving applications could affect the operation of the Urmet CallMe application when it is active in background (off screen).

- Have a user account correctly configured.
- Have a Call Forwarding Device correctly installed and configured and able to access the Internet.

For more information about installation and configuration, please check with your installer.

Whenever there is an incoming a call, your smartphone will ring and a notification will be shown.

By accessing the notification, you will open the Urmet CallMe App - displayed as follows:

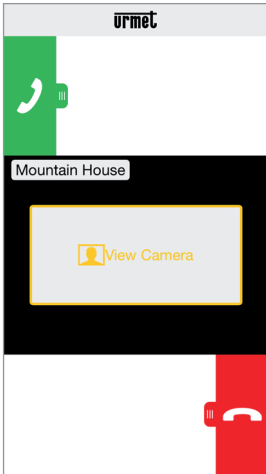

Incoming Call

There are 3 possible options:

1) Select "View camera".

By clicking on "View camera" you can see your visitor's picture before answering the call. This feature is particularly useful when you wish to 'make sure' who is at the door before taking any action. This could be the case if you wish to help elderly or sick family members be sure of the identity of their visitors. Displaying the caller picture will not prevent being able to answer the video door phone installed indoors.

2) Answering the call

A call can be answered (either immediately or after having visually checked the visitor via the key "View camera") by swiping the green answer key  from left to right.

3) Rejecting the call

To reject a call just swipe the red reject key  from right to left.



After selecting "View camera"

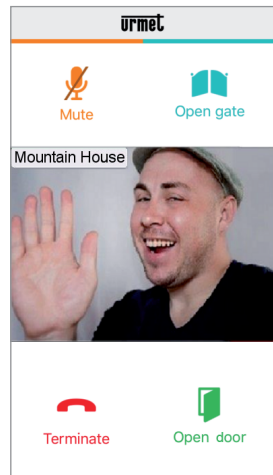

Once the conversation has begun, the display will show:



Conversation

To turn off your audio channel during the conversation, tap the "Mute" key. Press again to turn it back on.

The "Open door" key will open the main door.

 The garage gate will not open even if the  button is present in the Urmet CallMe app.

To end the conversation tap the "Terminate" key.

 The conversation may last for up to 2 minutes.

 If your smartphone is being used for a telephone conversation, any video door phone calls cannot be successfully handled and the corresponding notifications will not be shown by the Urmet CallMe App. It will still be possible, however, to answer a video door phone call from the indoor station inside the apartment.

If your smartphone is being used for a video door phone call, this will be interrupted by an incoming phone call.

## 1.2. INTERCOM FUNCTION BETWEEN SMARTPHONES

By pressing the “Intercom”  key in the Home Page of the Urmet CallMe App

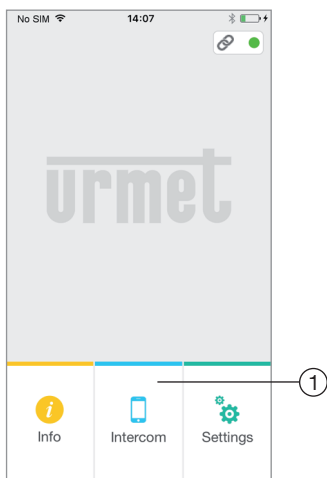

Key for Intercom Calls

you can forward a call (voice only) to any other registered smartphone connected with the same User Name. The call will be forwarded in broadcasting mode to all the smartphones registered under the same account: the first to answer will begin the conversation.

 With the “Intercom” key, only the other smartphones (and not the indoor station inside the apartment) can be called.

The user who is the forwarder of the call will see this screen:

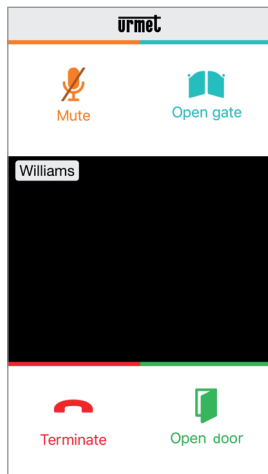

Intercom call forwarding

The receiver of the call will see a plain incoming call screen: it will be possible to distinguish between an intercom call and a call from an outdoor station by simply checking the name that is displayed in the top left corner, i.e. the name of your account. Although the “View camera” window may appear in the middle of the black window, even if you try selecting it no camera picture will be received.

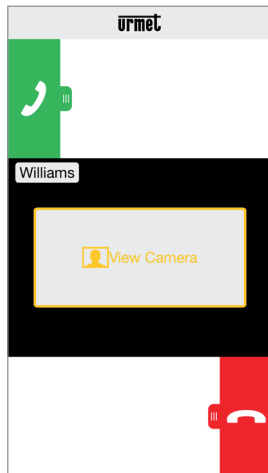

Receiving an Intercom Call

Once the call has been accepted, the two smartphones start interacting: the centre screen on the called user’s smartphone will be dark and although the “Open gate” and “Open door” keys may be visible, they will not be active.

 The conversation will stop after about 2 minutes.

## 2. THE Urmet CallMe APP

Download the application from the *Apple Store* (iOS) or from the *Play Store* (Android).

Launch the application taking care to enable notification receiving (necessary in order to receive calls). Wait for the following screen to be displayed:

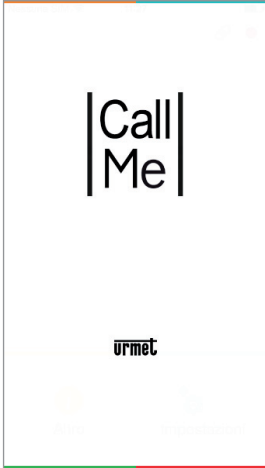

Opening the App

Immediately afterwards, the Home Page will be displayed:

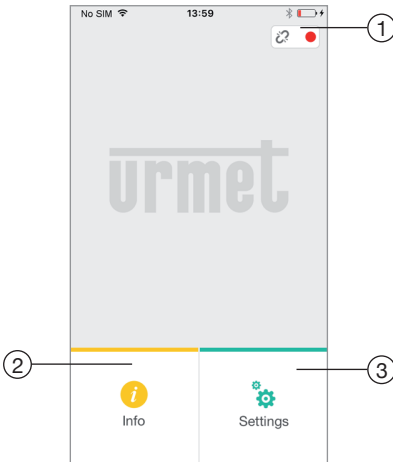

Home Page

The meaning of the icons and buttons in the Home Page is as follows:

### 1. “Status icon”:

- If the dot is red ● with an open chain 🔗, this indicates that the user is not logged in with an own account <username>@sip.urmet.com

 *THIS IS THE SITUATION THAT OCCURS WHEN THE APP IS LAUNCHED FOR THE FIRST TIME.*

- If the dot is green ● and the chain is closed 🔗, this indicates that a connection has been successfully established.

 *THIS IS THE NORMAL CONDITION WHENEVER YOU LAUNCH THE APP AFTER YOUR FIRST LOG-IN. THE CONNECTING SPEED TO YOUR ACCOUNT CAN BE INCREASED BY TAPPING THE DOT (WHEN STILL RED).*

- If the dot is yellow/orange ● and flashing and the chain is closed 🔗, this indicates that the connection has been successfully established but call receiving has been disabled on the device currently in use.

### 2. By pressing the “Info” key, the Software Version of the app will become available for reference and you will be able to access the instruction booklet (full version) of the device.



Info page

### 3. By pressing the “Settings” key you will display the following page:

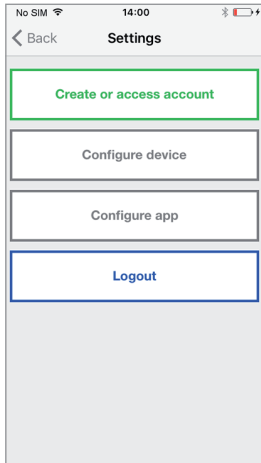

Settings page with account not connected

 Certain keys are only accessible after creating an account and logging in with that account. This is intended to make the system more user-friendly.

By pressing the “Exit” key you will quit the application.

#### **WARNING**

After exiting the application you will no longer be able to receive calls.

### **3. CREATE A NEW ACCOUNT OR USE A SAVED ACCOUNT**

In order to use the App you must select the first Menu “Create or access account”, the following page will open:

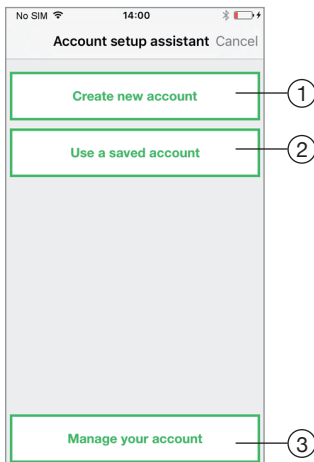

Create a new account or use a saved account

Below is the meaning of each key:

1. This is the correct selection if you do not yet have an account with @sip.urmet.com (first access).
2. This should be used if you already have an account.
3. Menu normally only used at a later stage, to make changes to your account (e.g. change password, email address, etc.)<sup>(1)</sup>.

(1) *This item is always available as it is necessary in special cases - e.g. should you change your mobile phone.*

In the following paragraphs are descriptions of the individual menus.

#### **3.1. CREATE NEW ACCOUNT**

Normally, a user does not have an own account on the server sip.urmet.com.

From this screen, it is therefore possible to create one - a necessary condition to be able to use the service.

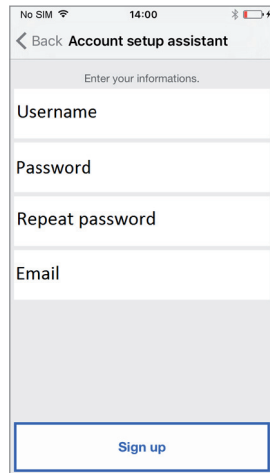

Configuration Wizard: Account Creation

Enter your desired user name (e.g. Williams), password, re-enter the password for confirmation and indicate a valid email address. The password must meet the following security requirements:

- It must have a length of at least six characters.
- It must contain at least one upper case character.
- It must contain at least one lower case character.
- It must contain at least one digit.
- It must not contain the user name.

By hitting “Sign up” the App will send an email to the specified address, and the user will be redirected to the settings page.

In order for the account to become active, you need to log in to your email in-box, retrieve the mail that has just been received and click on the validation link.

Click on “Continue” and the App will register the new account. From here you will be referred to the Home Page where, a few minutes later, the green dot ● will be displayed with a closed chain 🔒 to indicate that connection was successfully established.



Home page

### 3.2. USE A SAVED ACCOUNT (SIGN IN)

If, however, the user already has a sip.urmet.com account (e.g. one previously created on another smartphone), (s)he will be able to register directly from the menu “Use a saved account” and enter the account credentials:

- User Name
- Password

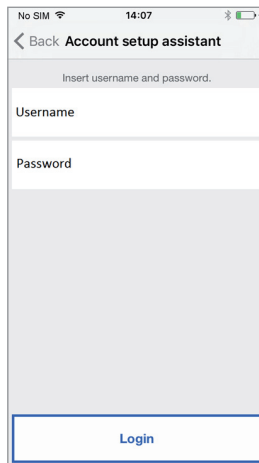

Entering Existing Account Details

In this case, too, the user will be automatically referred to the Home Page where, a few minutes later, the green dot ● will be displayed with a closed chain 🔒 to indicate that connection was successfully established.



Home page



Note that up to four smartphones can be registered on one account while the same account may be registered on multiple call forwarding devices.

### **3.3. ACCOUNT MANAGEMENT**

The “Manage Your Account” menu item can be used to:

- Ask sip.urmet.com to mail you your forgotten username or password (providing you enter the mail address with which your account was first registered).
- Change your password.
- Change your email address.

These are all standard IT operations and do not require any special explanations.



# INSTALLER MANUAL

## 4. DEVICE CONFIGURATION FROM THE Urmet CallMe APP

In order to configure the device, you must first have created an account (or logged in using an existing account), as explained in paragraphs 2 and 3.

**WARNING:** the device, once fully operational, will forward calls to the owner of the account that is used in the configuration step. It is therefore necessary to use the account of the end user during configuration operations.

From the Home Page, (with the green dot ● displayed and chain closed 🔒) select the “Settings” key.

You will display:

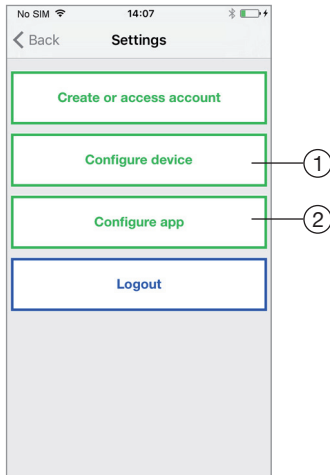

Settings Menu

From here, select “Configure device” ①. Follow the directions supplied ② and press “Continue”:

(2) **WARNING:** the first time the device is turned on it will take about 50 seconds before the LED starts flashing.

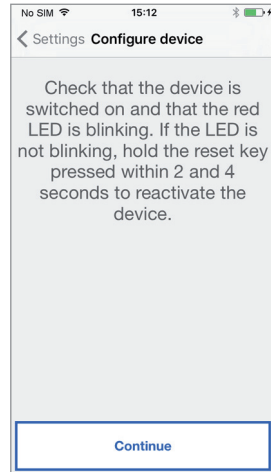

Configuring Instructions

After selecting “Continue” you must turn on the Wi-Fi on your mobile phone, and access the Wi-Fi network created by the device. Key in the suggested password. (WARNING: Do not forget to enter the dash sign ‘-’ between the required two identical repeats).

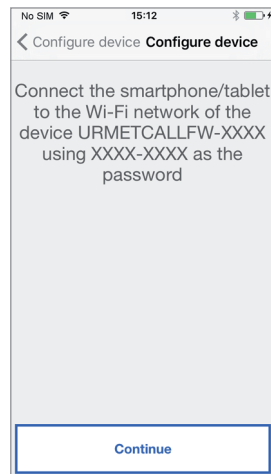

Password Info

On the next page you will be able to choose the name that you wish to give to your device (the name that will be displayed as ‘Caller’ when you receive an incoming call). We recommend setting your home address (street or city name) as the device name. Now press “Enter” and then “Continue”.

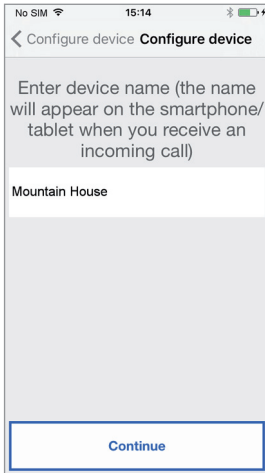

*Enter the device name*



*Connection via Wi-Fi*

To operate, the device must be connected to your home LAN network and this in turn must be connected via a modem/router to the Internet. The connection to your home LAN can be achieved via wire or by hooking up to your home Wi-Fi. Choose which type of connection you wish to use - either "Wire" or Wi-Fi ("Wireless").

it is essential to select from the dropdown menu the (home) network to connect to.

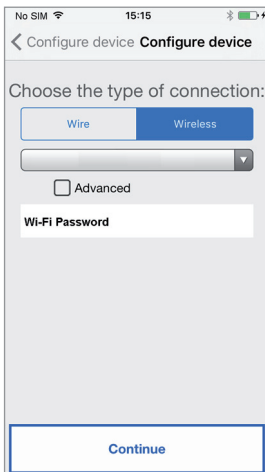

*Choose the connection type*

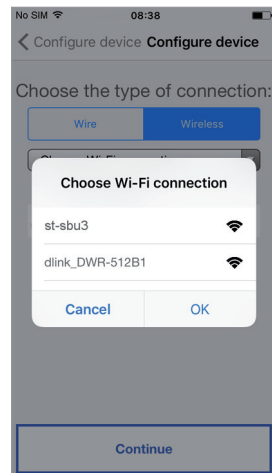

*Sample list of available networks*

If you choose the wired connection, you will go directly to the IP address configuration step (see below).

While if you choose instead the connection via Wi-Fi,

After you have selected it, press "OK" to confirm. In the next screen enter the network Password and press "Continue"<sup>(3)</sup>.

(3) Tick "Advanced" only for access to special settings, e.g. access to hidden networks.

With the wireless configuration it is optionally possible to identify up to two time intervals during which the Wi-Fi will be automatically switched off daily (e.g. nightly from 11:00 P.M. until 7:00 A.M.): during these intervals, the LED on the Call Forwarding Device will be lit (steady orange light.)



*Wi-Fi Switch-off Intervals*

After setting the time intervals (as an optional operation) press “Continue” to go to the next page.

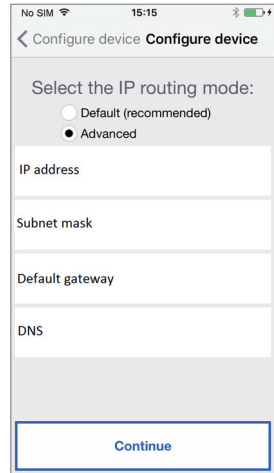

*Advanced Settings*

Enter the following values in the empty fields: IP Address, Subnet Mask, Default Gateway and DNS (e.g.: 8.8.8.8) then press “Continue”.

Now, it will be possible to choose the VIDEO quality<sup>(4)</sup> (Default value: LOW) then press “Continue”.

- (4) *A LOW video quality allows for operation notwithstanding the Internet connection speed. Unless you are absolutely sure to have a high Uploading rate, select MEDIUM or HIGH speed.*

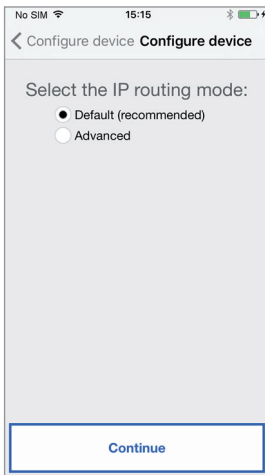

*IP Routing Mode*

It is preferable to choose the default configuration options. Should this be not possible, if the network to which you wish to connect requires a fixed IP address, select the option “Advanced” to open the following page:

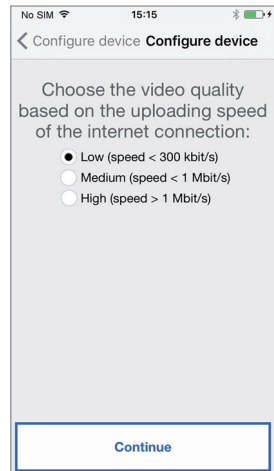

*Selecting video quality*

Pressing the “Save” key allows the device to store the configuration.

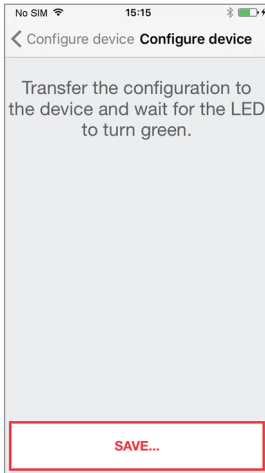

*Configuration saving*

After the configuration has been successfully completed, the following screen will be displayed:

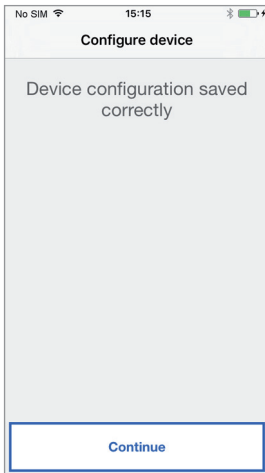

*Configuration End*

After pressing “Continue”, you will now be returned to the HOME PAGE and you will be ready to start using the application.

## 5. Urmet CallMe CONFIGURATION MENU

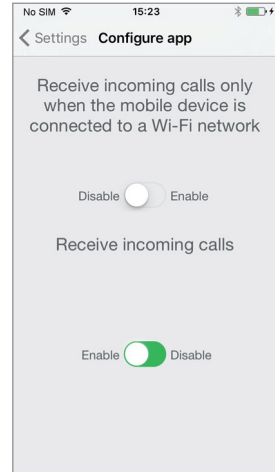

*App Configuration Menu*

Optionally, the Urmet CallMe application can help you to:

- Limit incoming calls to periods in which the device is connected to a Wi-Fi network, which will save your SIM card data allowance.
- Disable incoming calls without having to log out; in this case, calls will no longer be received until the switch is set back to “Enable”.

 *To show the user that incoming calls have been disabled in the App setup page, the status icon in the home page will be on (yellow/orange light) and flashing.*

## 6. DEVICE INSTALLATION

Installation of the device must be carried out by a skilled installer.

The product is designed to be powered according to national system regulations.

The Call Forwarding Device can be used to forward a voice-video call or a voice-only call to a smartphone with the Android or iOS operating system.

This is done by establishing an Internet connection through an ADSL router/modem or via 3G/4G using a Cat5 cable or via Wi-Fi.

 *The device was designed for use in homes and can be used to configure*

only some network parameters. It may consequently not work on specific business IP networks.

The Urmet CallMe App must be downloaded to the user's smartphone, connected to the Internet via a mobile data or Wi-Fi connection, in order to be able to receive the call.

In addition to receiving the call, the Urmet CallMe App also ensures intercommunication with other smartphones connected to the same account. Moreover, the Urmet CallMe App is necessary to be able to configure the device parameters.

 *The Call Forwarding Device only works in combination with one or more indoor stations available in the apartment.*

To ensure correct operation of the Urmet CallMe App, some essential requirements must be verified:

- 1) good Wi-Fi signal quality on the device;
- 2) upload data band  $\geq 300$  kbps for the Internet service supplied by your home provider to the device;
- 3) check that your smartphone data plan does not require VoIP data flow locking.

### WARNING

Applications that:

- optimise the use of the battery,
- ensure energy saving for your smartphone,
- protect the device (antivirus or similar software),

could adversely affect the operation of the Urmet CallMe application when in the off-screen (background) mode.

The device was tested on the following basic system types:

- 4+n wire door phone with electronic call or buzzer;
- Video door phone with coaxial cable and electronic call.

Operation on different types of systems is not guaranteed.

The Call Forwarding Device can be installed in one of the following ways:

## 6.1. IN A CONTROL PANEL

1. Insert the spacer behind the device in its special seat, ensuring that it is locked by the lever A.

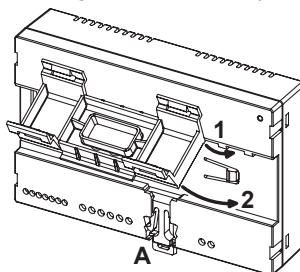

2. Insert the retainers B of the spacer in the DIN rail in such a way that the terminal strips of the device are pointing downwards, then insert the retainers C.

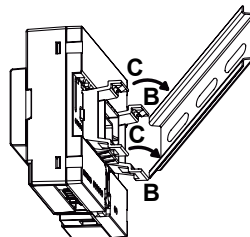

3. Couple the power supply provided on the DIN bar on the left of the device.
4. Remove the terminal strip cover.

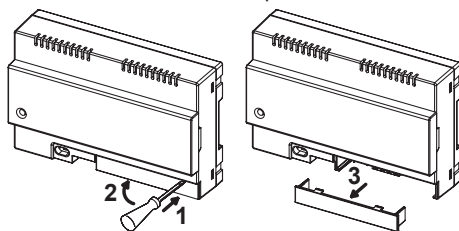

5. Connect the device to the system and to the power supply provided.

 *The end of a stranded conductor must not be consolidated with mild soldering in the points in which the conductor is subject to contact pressure.*

6. Carry out the device configuration by means of jumpers and/or dip-switches.
7. Replace the terminal strip cover.
8. Power on the device.
9. Complete your parameter configuration by using the Urmet CallMe App.

## 6.2. WALL MOUNTING WITH THE KIT REF. 1083/88

1. Fix the base of the container (supplied in the kit) to the flush-mounting box mod. 503 or Ø 60mm as shown in the following figures:

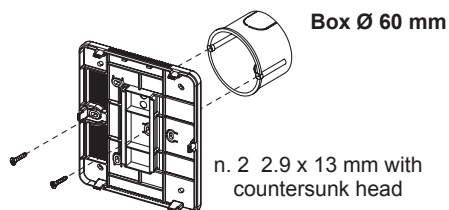
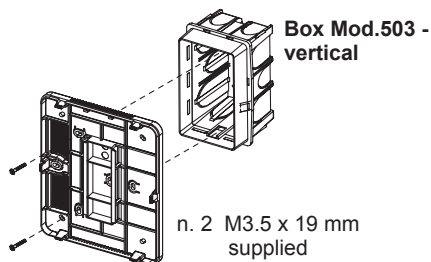
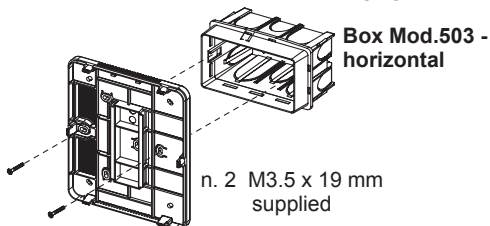

or, alternatively, with screws and anchors supplied in the kit.

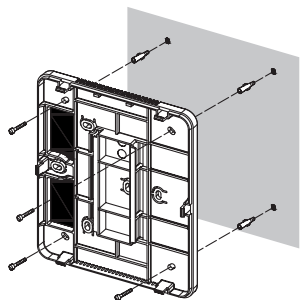

 Ensure cables are led through the left side.

2. Remove the 2 covers from the device.

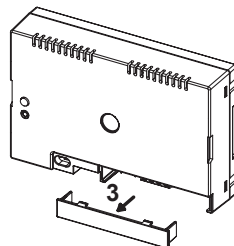
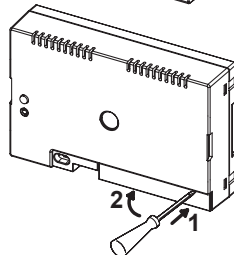
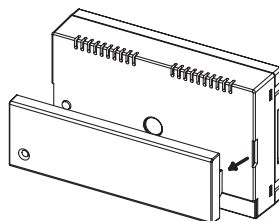

3. Secure the device to the base in the recommended position.

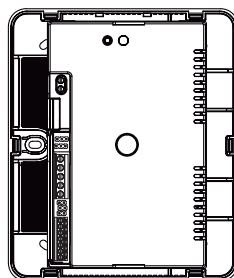



4. The local power supply must be installed in the electric panel or a cabinet.
5. Connect the device to the system and to the power supply provided.

 The end of a stranded conductor must not be consolidated with mild soldering in the points in which the conductor is subject to contact pressure.

6. Carry out the device configuration by means of jumpers and/or dip-switches.

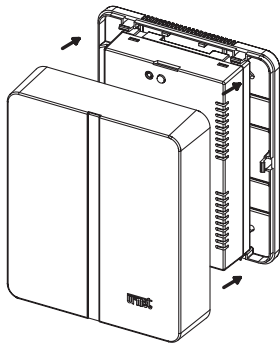
7. Replace the terminal strip cover on the device (the second transparent cover should not be used because it prevents cover closing).
8. Power on the device.
9. Complete your parameter configuration by using the Urmet CallMe App.
10. Install the cover.



 If, at a later stage, it becomes necessary to remove the cover use a screwdriver in the indicated points.

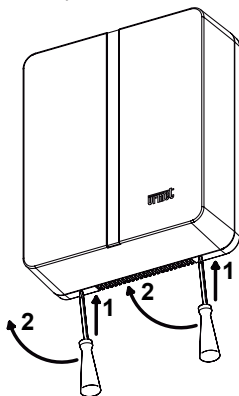

## 6.3. DESCRIPTION OF COMPONENTS

### Call Forwarding device for 4+N

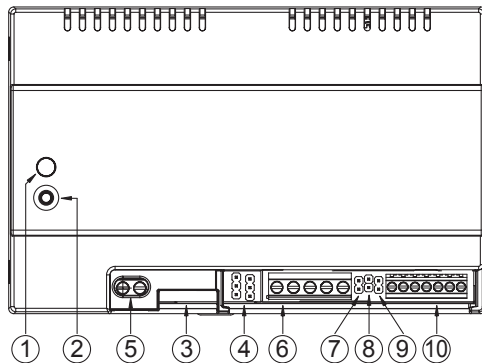

1. **STATUS LED:** LED showing the state of your Internet connection.

- **flashing red light:** the device is turned on in the configuration mode;
- **steady green light:** the device has been correctly registered with the Urmet SIP server and is ready to forward calls to a smartphone;
- **flashing green light:** the device is in Upgrade mode;
- **steady red light:** the device is showing that there is no Internet connection;
- **steady orange light:** device not enabled (no active Wi-Fi.)

 During power-on or after pressing the PROGR/RESET key, the device will need 50s to start up; during this time, the LED will remain off.

2. **PROGR/RESET key:** by pressing the button for a time

- **comprised between 2s and 4s,** the device will restart in the configuration mode (maintaining any parameters that had already been configured);
- **shorter than 2s or longer than 4s,** the device will be restarted.

 After 5 short consecutive presses (at time intervals shorter than 1s) the device will restore its factory parameters and signal the event with a flashing red/orange/green LED light, to then switch to the configuration mode.



 After 3 short consecutive presses (at time intervals shorter than 1s) the device switches to Upgrade

mode. The green LED will blink continuously to indicate the event.



- LAN connector:** Ethernet port for wired connection to the home network.
- Jumpers to define the type of power supply to the device.**

	Power from external local power supply (DEFAULT) <b>DO NOT MOVE</b>
---	--



- +/- 24V terminals:** external local power supply terminals.
- Terminal board R2, R1, V3, V5, V4**  
R2: video power positive (+18Vdc).  
R1: video power earth.  
V3: composite video signal input.  
V5: composite video signal (shield) earth.  
V4: composite video signal output.
- Jumper 6-10:** for selecting closing/separation of the audio earth to the door opener earth.

	Short-circuited audio earth and door opener earth (DEFAULT)
	Separate audio earth and door opener earth

- Jumper A-V:** for selecting the type of door unit to which the device is connected.

	Door phone
	Video door phone (DEFAULT)

- Jumper 1-1A:** for selecting call type.

	Door phone with buzzer
	Door phone/ video door phone with electronic call function (DEFAULT)

- Terminal board RD, CA, 10, 9, 1, 2, 6.**  
RD: video power input/output (positive).  
CA: call input (electronic or to buzzer).  
10: door opening earth.  
9: door opener control.  
1: audio output (door phone speaker).  
2: audio input (door phone microphone).  
6: audio earth.

## Power supply (provided)

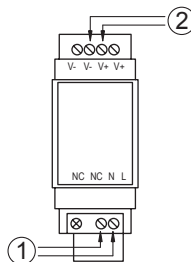

- N, L terminals:** Input voltage 110/230Vac
- V-, V+ terminals:** Call-Forwarding device power voltage output

## 7. TECHNICAL SPECIFICATIONS

### Call Forwarding device for 4+N

External input voltage: ..... 24 V  $\equiv$   
 Maximum absorption: ..... 200 mA  
 Absorbed power in operation: ..... max 6 W  
 Operating temperature: ..... -5 ÷ +45° C  
 Max humidity: ..... 95% RH  
 Ethernet interface: ..... 10/100 Mbps  
 Wi-Fi: ..... 2.4GHz  
 (conforms to IEEE 802.11 b/g/n)  
 with internal antenna

Dimensions (LxHxD):  
 140 (~8 DIN modules) x 90 x 60 mm.

 *The product is designed to be powered by external power supply Ref. 1083/24 via 24V (6 W, 24 V  $\equiv$ ) terminals, with power supply up to the specified power source requirements (LPS) and protected against short circuits and overcurrents according to EN 60950-1:2006+A11+A12+A2 provisions.*

### Power supply (provided)

Power supply: ..... 100-240 Vac 50/60 Hz  
 Power: ..... 12 W max  
 Secondary output: ..... 24 V  $\equiv$  0,42A



Power dissipated after after 1 hour of functioning:  
**max 11 Wh (~40 KJ)**

Dimensions (WxHxD):  
**36 (2 DIN modules) x 98 x 60 mm**

## 7.1. KEY TO SYMBOLS

Symbol	Description
---	Direct input voltage
	DANGER - Presence of safety-critical components

## 8. SIMPLIFIED EU DECLARATION OF CONFORMITY

---

Hereby, URMET S.p.A. declares that the radio equipment type:

**Call Forwarding Device for 4+N Ref. 9854/58**

is in compliance with Directive 2014/53/EU.

The full text of the EU declaration of conformity is available at the following internet address:

[www.urmet.com](http://www.urmet.com)

# 9. CONNECTION DIAGRAMS

## 9.1. VIDEO DOOR PHONE SYSTEM WITH ELECTRONIC CALL

SV102-3976

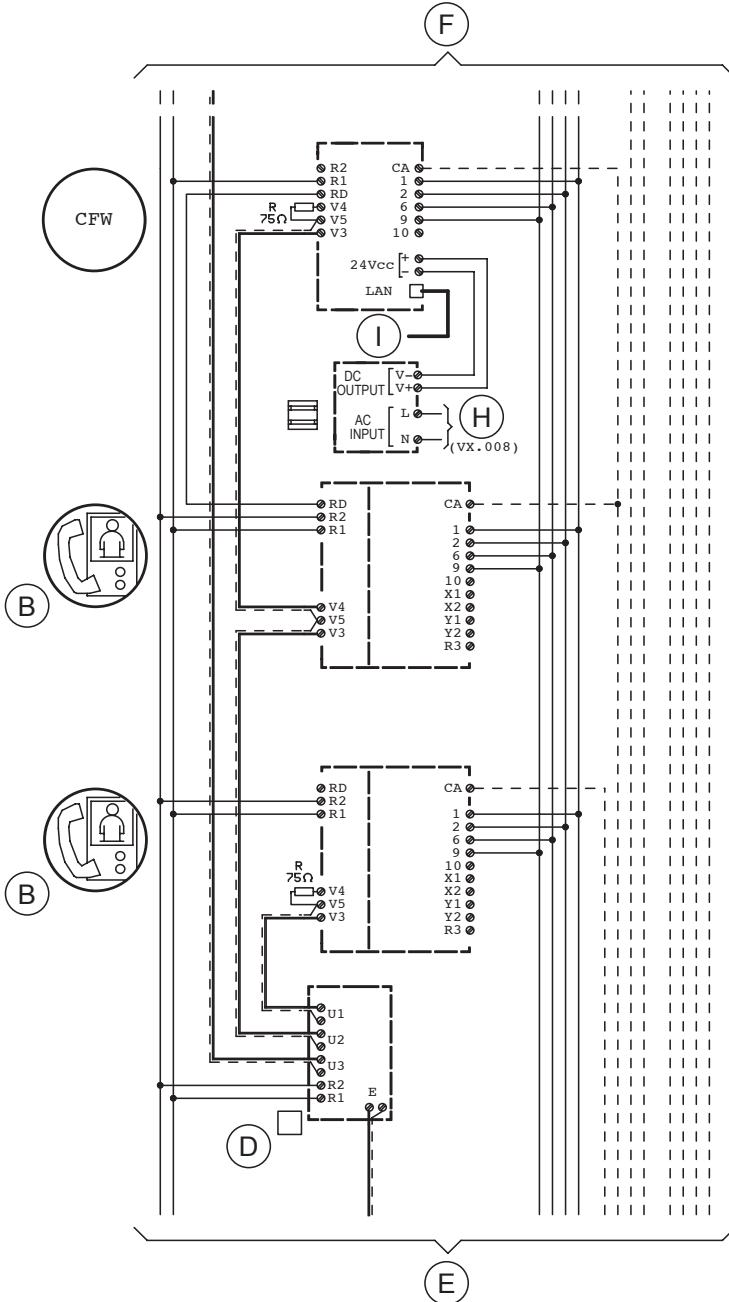

# 9.2. DOOR PHONE SYSTEM WITH ELECTRONIC CALL

SC101-1563

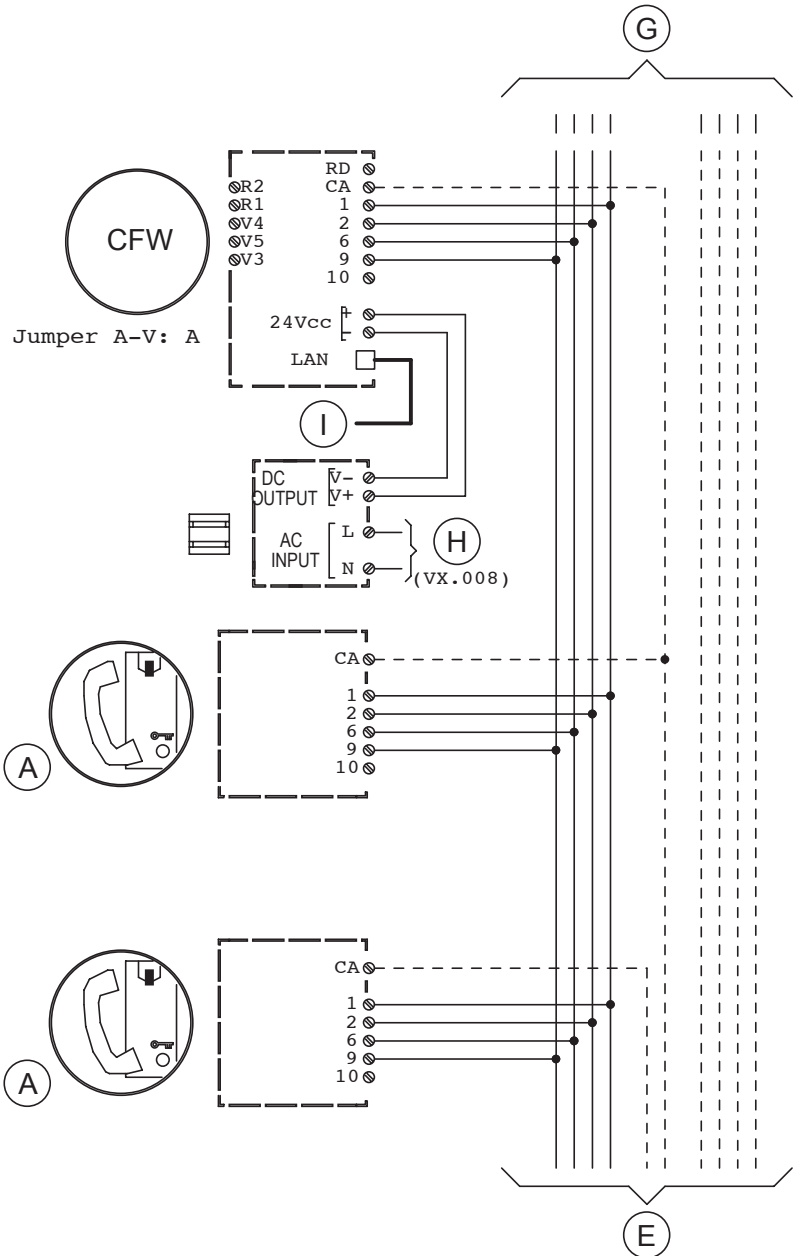

### 9.3. KEY TO DIAGRAMS

<b>A</b>	Miro door phone for 4+n systems Ref. 1150/xx
<b>B</b>	Signo video door phone Ref. 1740/40 with bracket Ref. 1740/90
<b>CFW</b>	Call forwarding device for 4+n Ref. 9854/58 with power supply included
<b>D</b>	Video distributor Ref. 1794/4A
<b>E</b>	From power supply to push button panel
<b>F</b>	To the next video door phones
<b>G</b>	To the next door phones
<b>H</b>	Line~
<b>I</b>	To router/modem ADSL or 3G/4G

### 9.4. NOTES ON DIAGRAMS

#### VX.008 (Rev. A)

Connect the devices to a filter and power line protection device.

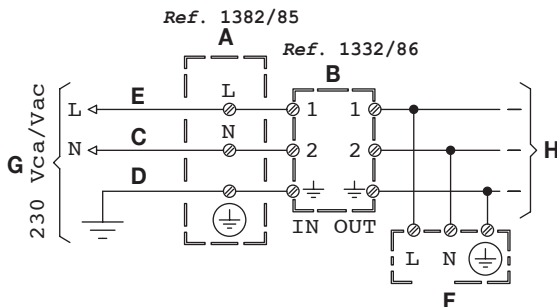

- |                      |                     |                   |                       |
|----------------------|---------------------|-------------------|-----------------------|
| <b>A)</b> Protection | <b>C)</b> (Neutral) | <b>E)</b> (Step)  | <b>G)</b> Mains 230V~ |
| <b>B)</b> Filter     | <b>D)</b> Earth     | <b>F)</b> Utility | <b>H)</b> Line~       |

**DS 9854-007C**

URMET S.p.A.  
10154 TORINO (ITALY)  
VIA BOLOGNA 188/C  
Telef. +39 011.24.00.000 (RIC. AUT.)  
Fax +39 011.24.00.300 - 323

**urmet**

**LBT 20283**

Area tecnica  
servizio clienti +39 011.23.39.810  
<http://www.urmet.com>  
e-mail: [info@urmet.com](mailto:info@urmet.com)

Designed by Urmet  
MADE IN CHINA